

Central Locking

Purpose of the System

The Central Locking System provides locking/unlocking of the entire vehicle from one central exterior point.

From the driver's door, passenger's door or luggage compartment (>96 MY), a lock/unlock request will lock/unlock all exterior doors, luggage compartment and the fuel filler flap (*and glove box E36iC only*).

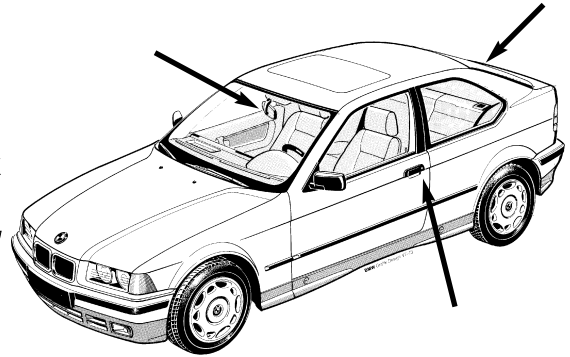

Locking from the luggage compartment lock cylinder and leaving the lock cylinder in the horizontal position will manually lock the luggage compartment in the "valet" position.

From inside, the vehicle can be locked using one of the front door lock knobs or a central locking button (>96 MY E36 which also unlocks the vehicle) located in the center console. *The doors can be unlocked by pulling twice on the interior door handle.*

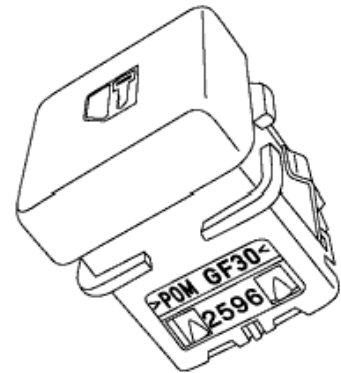

Locking the vehicle from the central switch or door lock knob will "single lock" all doors, luggage compartment and *not lock the fuel filler flap (or glovebox on the E36iC)*.

The Central Locking System utilizes the GM IV to carry out all of the locking/unlocking features:

- When locked from the outside, the vehicle will double lock and arm the alarm system (only if equipped with DWA, not the accessory Alpine Alarm). The ignition must be switched off and the driver's door must be opened and closed.
- The EWS II is interfaced for double lock monitoring and unlock function(>1/95 Production Date). With the presence of an accepted EWS II key and switching the ignition "on", the GM IV will unlock the vehicle.
- In the event of an accident (ignition must be switched on), the GM IV will be signalled to unlock all of the doors.

- Anti-theft drive away protection feature with double lock (>1/95 Production Date when locking the vehicle from the exterior).
- Comfort closing of the windows is possible from both front door locks if held in the lock position.
- 1996 E36 - Sunroof added to comfort closing feature.
- E36iC - The trunk is locked out when the convertible top is in operation. Fully automatic convertible top added to comfort closing feature (97 MY and later vehicles).

Hardware Features

- The door lock buttons are mechanically uncoupled from the lock actuators when locked. The door lock buttons also “mechanically” lock the individual doors. This provides manual locking in the event of a central locking malfunction.
- Child safety locks (located in the rear doors on a four door vehicle) are actuated by sliding a lever. The door can now only be opened from outside.
- The luggage compartment can be manually locked with a “Master Key” and leaving the lock cylinder in the horizontal position which prevents opening by any other method (secured for valet).
- The Fuel Filler Flap mechanical release is found in the right side of the luggage compartment.
- The glove box has a lock cylinder to secure the contents by manual locking with a “Master Key” and leaving the lock cylinder in the horizontal position which prevents opening by any other method (secured for valet).

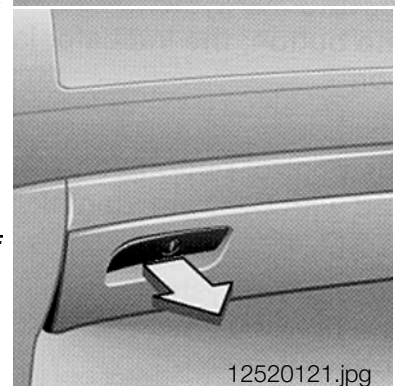
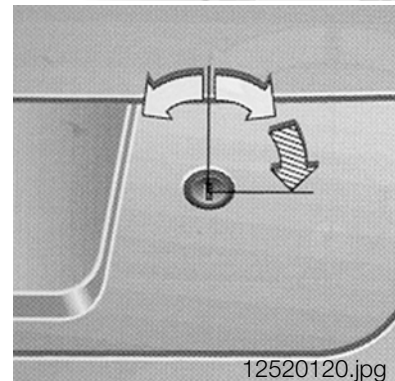
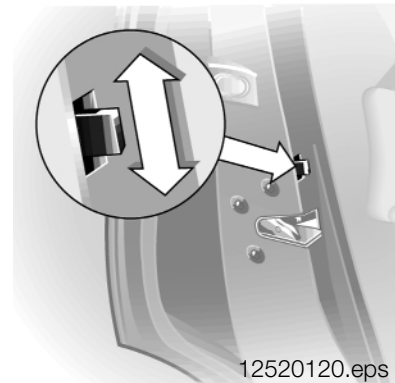

The valet key is not mechanically capable of entering either of these lock cylinders.

Central Locking - ZKE IV

The locking and unlocking of the lock actuators is controlled from three relays in the GM. The door lock actuator "Pin Contacts" and lock micro-switches provide the inputs to the GM for locking/double locking and unlocking of the doors, trunk, fuel filler flap (and glove box on the E36iC only). The relays in the GM provide both power and ground depending on the direction of actuator movement (lock/unlock).

System Components: Inputs - Processing - Outputs

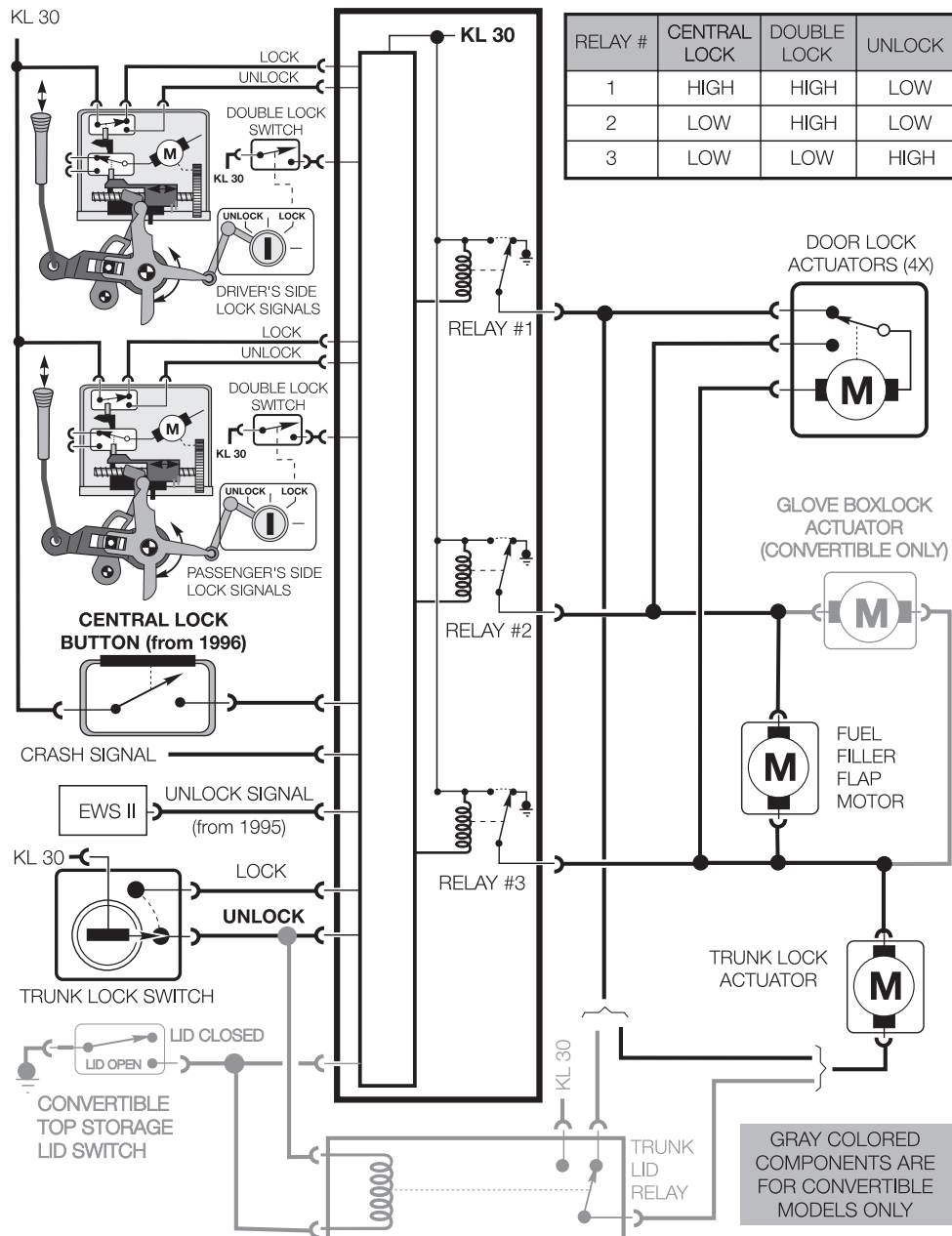

Lock Actuator Operation

The lock actuators contain the electrical motor drive, the lock/unlock switch contacts and the integral single/double lock limiting switch.

The actuators control the mechanical locking/unlocking function of the doors by sliding two protruding levers. The precise positioning of the levers provides the unlock, single lock and double lock positions of the latch mechanism.

The electro-mechanical operation of all the lock positions are provided on the following pages:

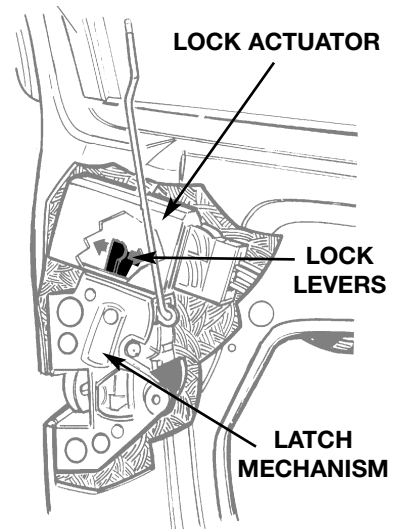

UNLOCKED-NEUTRAL POSITION

UNLOCKED-NEUTRAL POSITION

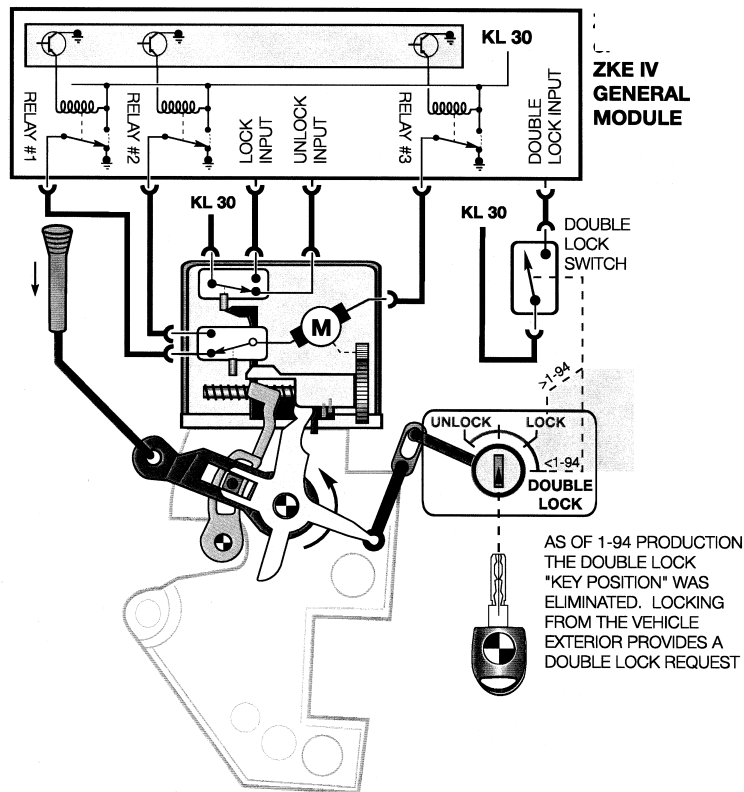

- All switch contacts are in their rest positions.
- The lock actuator/latch mechanisms are in the unlocked position.
- Raising the door handle or pulling the interior door latch will mechanically open the door.

Central Locking System Terminology

“Single lock”, “Central lock”: Vehicle is locked via the lock knob, or the console mounted central lock button (>12-95 prod).

“Double lock”, “Central arrest”: Vehicle has been locked from the exterior with the key at the driver’s door, passenger’s door or trunk.

SINGLE LOCK - Phase 1, mechanical lock at door and lock signal generation

SINGLE LOCK - Phase 1, mechanical lock at door and lock signal generation

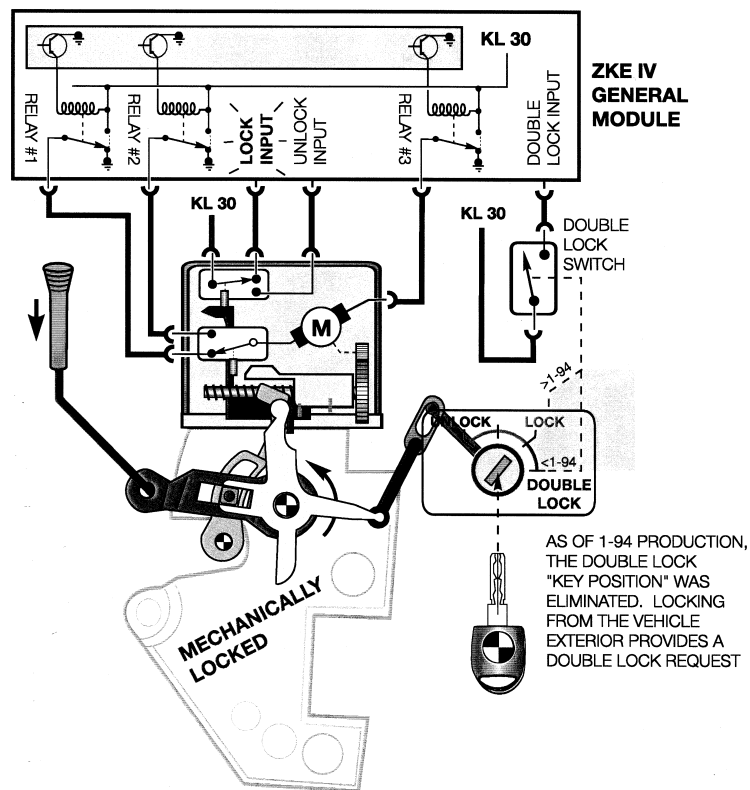

- The lock button and key mechanically rotate the lock lever which decouples the exterior door handle from the latch.
- When rotated, the lock lever also slides an internal switch ramp to the left closing the lock microswitch.
- This provides the lock signal to the GM (cont'd on next page.)

SINGLE LOCK - Phase 2, activation of actuators at all door locks

When the GM receives the lock signal it activates internal relay #1, providing power through the closed single lock contact to the actuator motor. Ground is provided through the module's closed contact of relay #3.

All of the vehicle's actuator motors are energized until the single lock circuit is opened by the gear driven slider. The actuators stop at the single locked position.

At this point, the external door handles are decoupled from the latch mechanism preventing entry from outside of the vehicle.

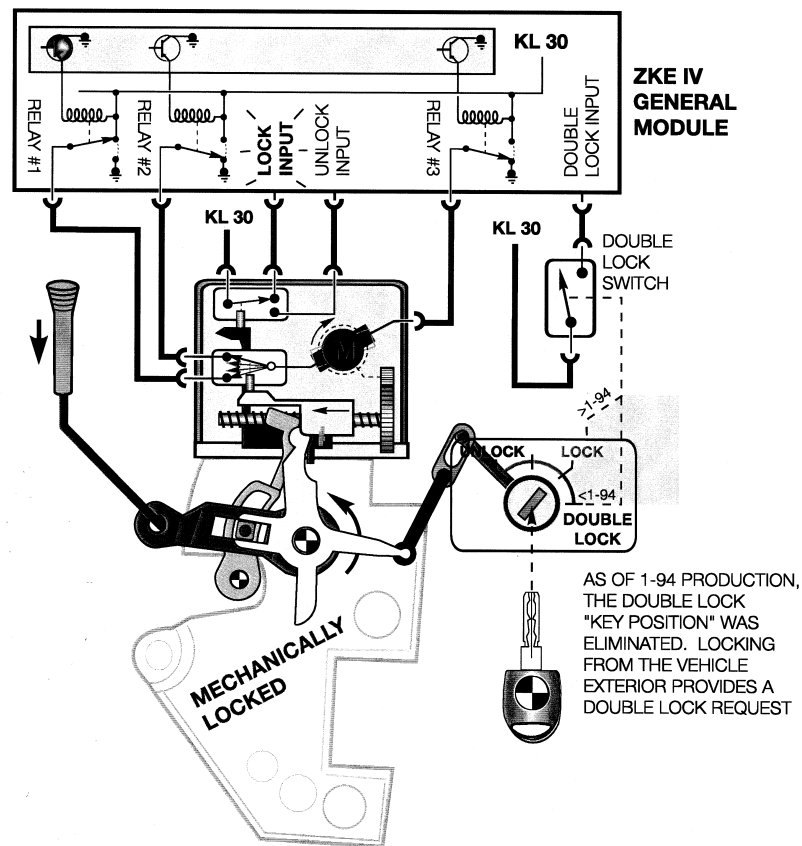

If the internal door handle, the lock buttons or the central lock button on the center console are operated, the door returns to unlock mechanically and can be opened.

DOUBLE LOCK - Electrical Activation

Turning the key from any outside lock cylinder causes the external double lock micro-switch to close. The GM recognizes this high signal as a double lock request.

The GM activates internal relay #2, providing continued motor operating power through the closed contacts of the internal double lock circuit. Ground is provided through the GM's internal relay # 3. The actuator motors are energized until the internal double lock circuit is switched back to the single lock circuit by the gear driven slider.

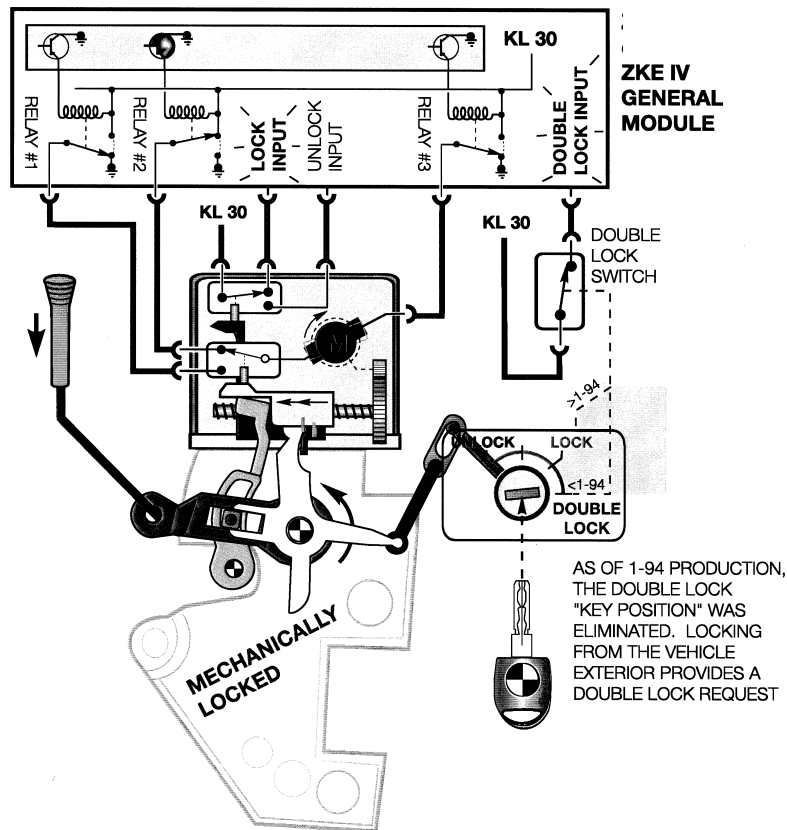

Notes: _____

DOUBLE LOCK - Mechanically Decoupled

When the slider switches the circuit back to single lock it also pushes the double lock lever to the left until it stops. In this position, the double lock lever decouples the lock button from the latch mechanism. The lock button can be pulled but will not unlock the door since it is not coupled to the mechanism. Spring pressure pulls the button back down when released.

At this point, unlock is only possible when a key is turned to the unlock position from an outside door lock or if the GM receives the unlock signal from the EWS II control module.

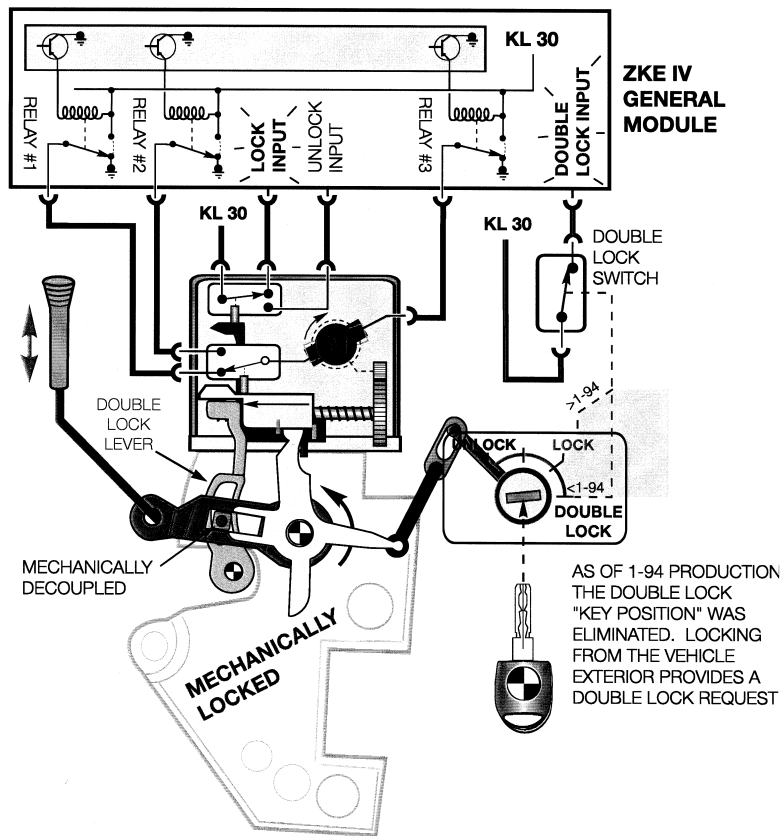

Notes: _____

UNLOCK FROM DOUBLE LOCK

When the GM receives the unlock request from a key location it activates internal relay #3 providing operating power to the actuator motor in the opposite direction.

The single and double lock circuits (internal relays 1 & 2) are not activated at all during the unlock function providing ground for the motor to bring the actuator back to the fully unlocked position.

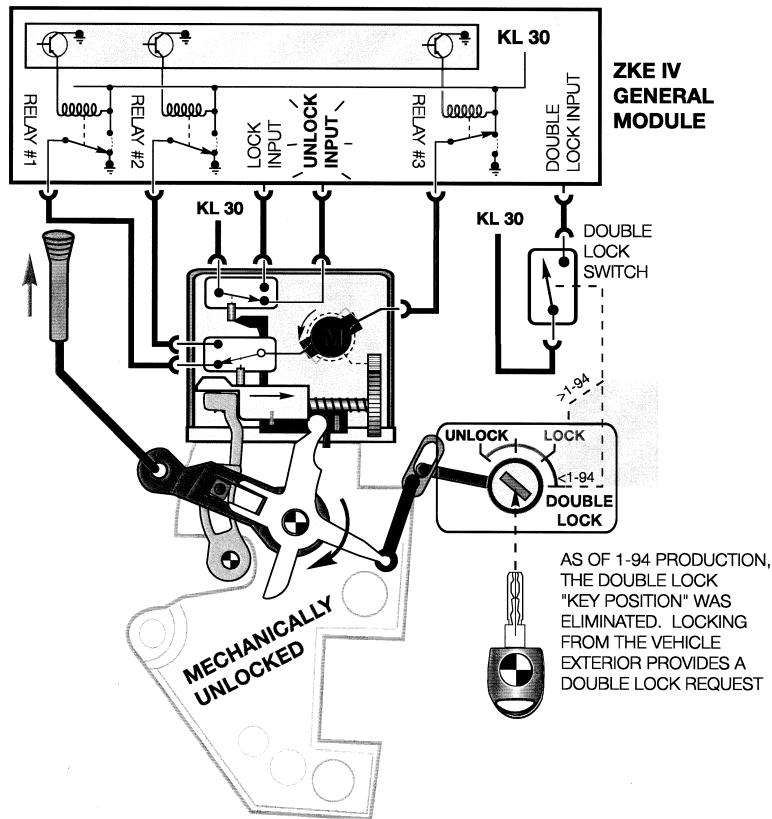

Notes: _____

Locking Protection

Power protection for the door locking circuit is provided by a “time monitored” activation of the door lock actuators by the GM. The door lock actuators are provided power for the duration of time needed to run the actuator to the desired position.

- The maximum on time for the actuators is 0.7 seconds.

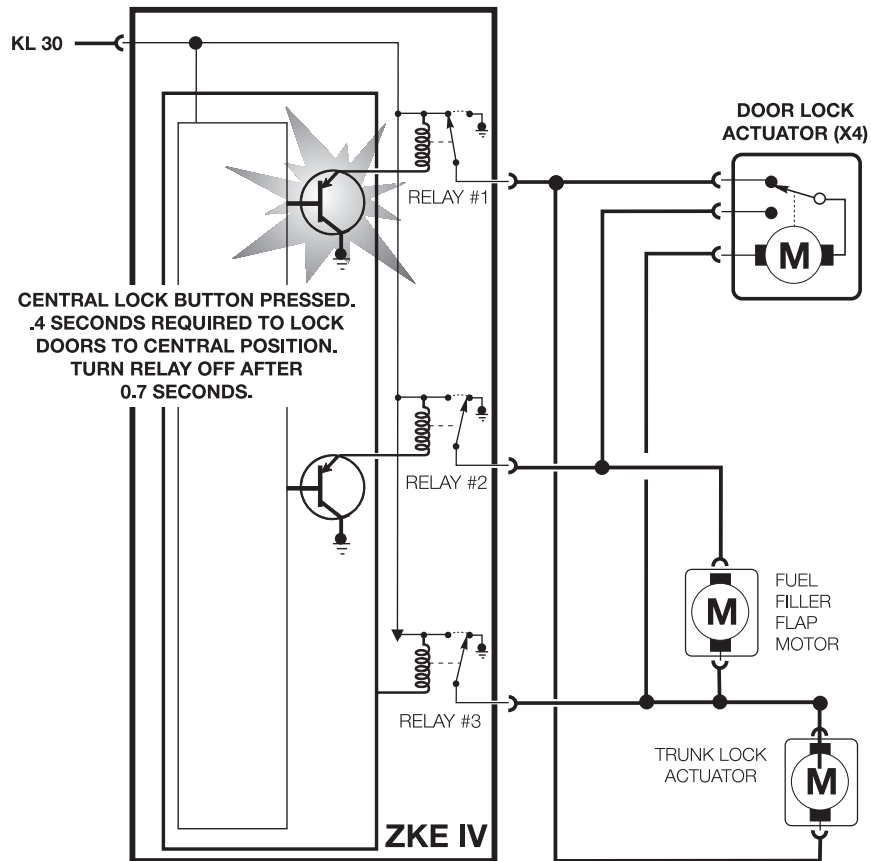

Crash Signalling

The Supplemental Restraint System control module provides a switched signal to the GM in the event of an accident. This signal was previously provided by the Crash Alarm located in the left front kick panel on earlier models (<97 MY).

The signal is an output function of the control module and becomes active when the impact threshold has been exceeded. The GM unlocks the vehicle, switches on the interior lights and signals the Crash Alarm Relay to flash the exterior lights when this signal is active.

Door Lock Heating (optional)

Purpose of the System

The *Driver's door lock cylinder* is surrounded by a heating coil to warm the lock cylinder in case it is frozen due to moisture and below freezing temperatures.

Principle of Operation

The GM controls the lock heater by providing voltage through a final stage transistor. The heater is switched on by raising the driver's door handle. Prerequisites for heater operation include:

- Vehicle locked
- Door handle raised for approximately 3 seconds

Power is applied to the heater for a maximum of 32 seconds. A timed arrest of 16 minutes is activated after 3 heating attempts. The door lock heater is switched off immediately after unlocking the door.

System Components: Inputs - Processing - Outputs

